

Passive Wireless Sensors Fabricated by Direct-Writing for Temperature and Health Monitoring of Energy Systems in Harsh-Environments

Graduate Researcher Team:

Michael Comparetto^a

Nandhini Ranganathan^b

Co-PI Team:

Dr. Daryl Reynolds^a

Dr. Edward M. Sabolsky^b

Dr. Kostas Sierros^b

^aLane Department of Computer Science and Electrical Engineering

^bDepartment of Mechanical and Aerospace Engineering

West Virginia University (WVU)



Background- Harsh Environment Sensing Needs

- Online monitoring of energy systems in extreme conditions is required for mining/drilling, transportation, aviation, energy, chemical synthesis, and manufacturing applications.
- Harsh-environments include:
 - High temperature (1000°C-2000°C)
 - High pressure (up to 1000 psi)
 - Various pO₂ levels
 - Corrosive conditions (molten inorganics or reactive gasses)
- Ability to monitor:
 - Temperature
 - Stress/strain within energy or reactor components
 - Failure events
 - Overall health



Processing Vision

Item A represents the organic carrier film.

Item B represents the polymer-precursor ink (converts to an electroceramic after heat treatment).

Item C represents a possible barrier layer.

Item D represents RF circuit sensor circuit printed on the transfer paper.

Item E shows the RF circuit pattern being placed upon the energy-system component.

Item F represents the pyrolysis of the organic carrier and bonding.

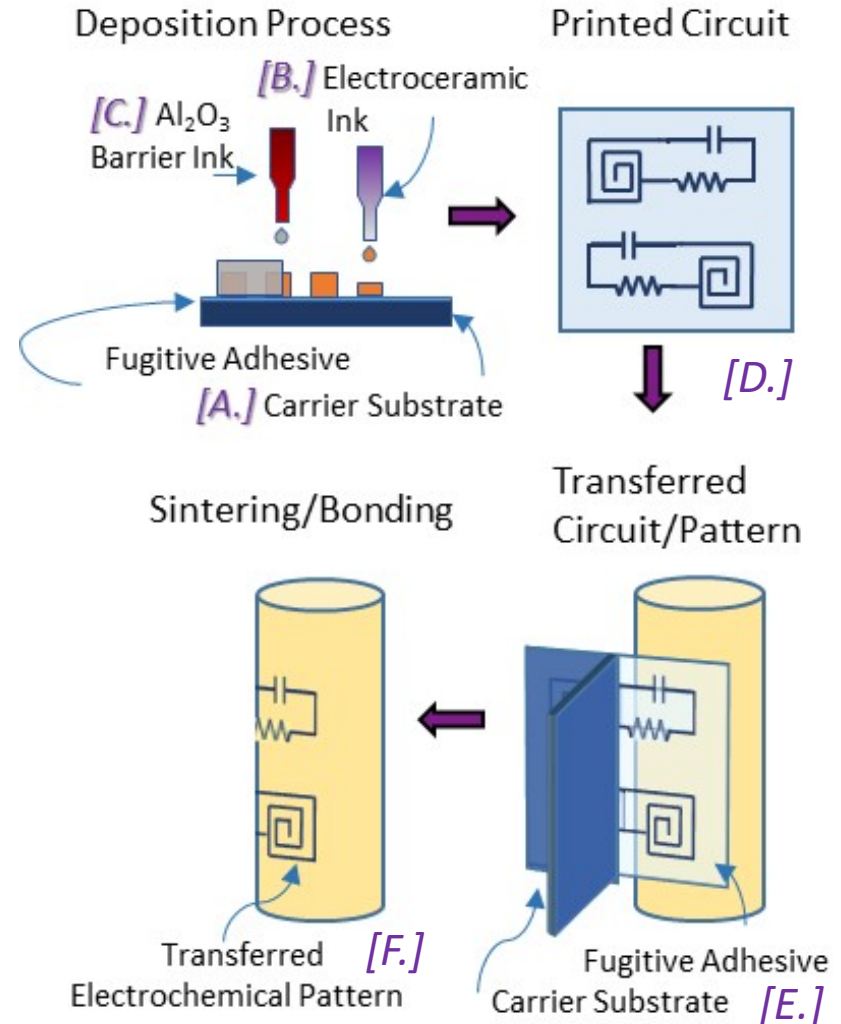

Program Objectives

- 1) Investigate phase formation, sintering/grain growth, and electrical properties of polymer-derived electroceramic composites between 500-1700 °C.
- 2) Define processes to direct-write through ink-jet and robo-casting the electroceramic composites onto oxide and polymer surfaces.
- 3) Develop methods to form monolithic “peel-and-stick” preforms that will efficiently transfer the sensor circuit to ceramic surfaces after thermal treatment.
- 4) Design of RF passive wireless LCR circuits and receiver (reader) antennas for communication and testing at temperature up to 1700°C.
- 5) Demonstrate the passive wireless sensor system developed for temperature and stress/strain measurements on a SOFC repeat unit and a singular gas turbine blade prototype as example applications.



R&D Team (Co-PIs)

Dr. Edward M. Sabolsky (WVU Mechanical and Aerospace Engineering) will act as PI of the program (both technical and administrative), and will be responsible for ceramics processing and sensor testing.

Dr. Kostas Sierros (WVU Mechanical and Aerospace Engineering) will lead development of micro-patterning and robo-casting of ceramic materials, and will be the co-developer of the printing inks and direct-writing tasks.

Dr. Daryl Reynolds (WVU Computer Engineering) will lead the electronics design, interfacing and circuitry, in addition to the development of the passive wireless communication and testing.

Dr. Andrew Nix (WVU Mechanical and Aerospace Engineering) 15 years of experience in turbine blade testing, and he will consult on the turbine blade demonstration testing.

Dr. Matthew Seabaugh and Mr. Gene Arkenburg (Nexceris LLC) are Director of Product Development and SOFC Group Leader, respectively. Assist in testing technology on SOFC platform.

Drs. Timothy Yosenick and Kristen Brosnan (GE Global Research) are Materials Scientist and Manager of Ceramic Structures and Processing Laboratory, respectively. Consult and mentor team for turbine blade application and demonstration.



Major Milestones:

Materials/Sensor Fabrication

- M1- (Task 2)⇒ Down-select composite composition for Task 3. (June 2016)
- M2- (Task 3)⇒ Define basic ink/paste formulation for printing. (June 2016)
- M3- (Task 3)⇒ Completed baseline sensor printing on oxide substrates. (January 2017)
- M4- (Task 3)⇒ First demo of pattern transfer. (March 2017)
- M5- (Task 3)⇒ First demo of circuit pattern transfer. (September 2017)

Passive Wireless Circuit Modeling and Testing

- M6- (Task 4)⇒ Completed design and testing of sensor circuit. (Sept. 2016)
- M7- (Task 4)⇒ Completed wireless coupling modeling for applications. (March 2017)

*Roughly 6-9 Months behind on schedule due to timing for bringing graduate students into the program.

- Nandhini Ranganathan (Ph.D. student)- materials/sensor research (started Jan. 2017)
- Michael Comparetto (M.S. student)- electronics/wireless research (started ~Mar. 2016)



***Task 2.0:
Fabrication and Characterization of
Polymer-Derived Electroceramic
Composites.
(Sabolsky, Ranganathan)***



Task 2.0 Objective:

- Investigate phase formation, sintering/grain growth, and electrical properties of electroceramic composites between 500-1700 °C.



Task 2.0 Approach:

- **Subtask 2.1 Synthesis of Multifunctional Electroceramic Composites through Polymer-Derived Precursors.**- Silicon-containing polymers such as polysilane, polycarbosilanes, and polycarbosiloxanes will be investigated as precursors to fabricate various electroceramic compositions. This will include the addition of fillers and reactive salts.
- **Subtask 2.2 Thermal Processing of Composite Compositions.**- Samples will be pressed into bars, and also screen-printed onto Al_2O_3 or ZrO_2 dense substrates (for initial observation on shrinkage effects). Thermal processing the materials in various atmospheres (air, inert, reducing atmosphere) will be completed up to 1700°C .
- **Subtask 2.3 Composite Material Testing and Characterization.**- Electrical testing (at high-temperature) and phase/chemistry characterization will be completed on the polymer-derived electroceramic composites.



Task 2.0 Current status:

- **Subtask 2.1 Synthesis of Multifunctional Electroceramic Composites through Polymer-Derived Precursors.-**
 - ✓ Silicon-containing polymer Poly di- methyl siloxane (PDMS) is investigated as precursor
 - ✓ Fabricated various electroceramic compositions
 - ✓ As a risk mitigation approach, lanthanum nickelate is also synthesized and characterized.

- **Subtask 2.2 Thermal Processing of Composite Compositions.-**
 - ✓ Samples are pressed into cubes for initial observation on shrinkage effects
 - ✓ Screen-printed onto yttria stabilized zirconia substrates to initiate task 4
 - ✓ Thermal processing the materials in inert atmosphere is done at 1500°C.

- **Subtask 2.3 Composite Material Testing and Characterization.-**
 - ✓ Phase/chemistry characterization is completed on the polymer-derived electroceramic composites.



Polymer-Derived Ceramics (PDCs):

- Polymers with silicon backbone attached to oxygen, carbon, nitrogen or boron atoms
- Thermal processing with metals yield silicates, silicon carbides, silicon nitrides, silicon borates which are ceramic in nature.
- ISSUES:
 - Off-gassing of short organic molecules and potentially CO/CO₂
 - Large volumetric shrinkage
 - Cracking, voids, and delamination (if formed as films)

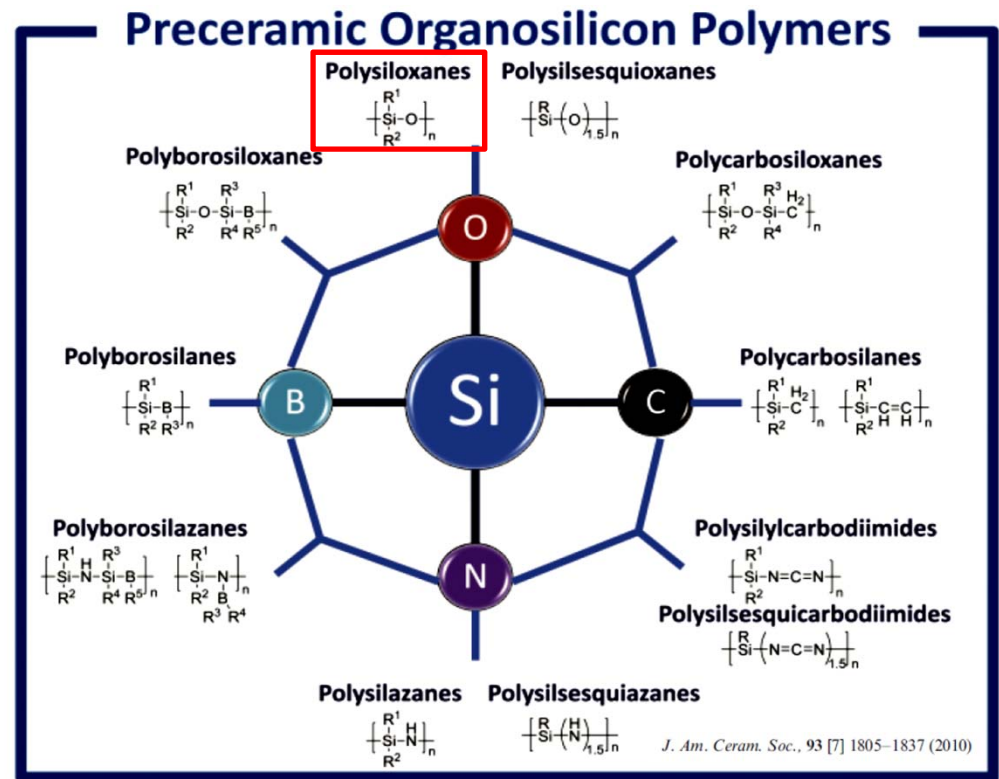

System 1: Polymer Derived Ceramics (PDCs)

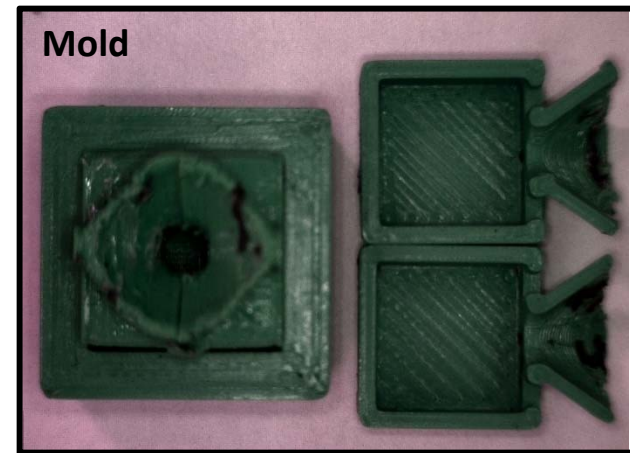
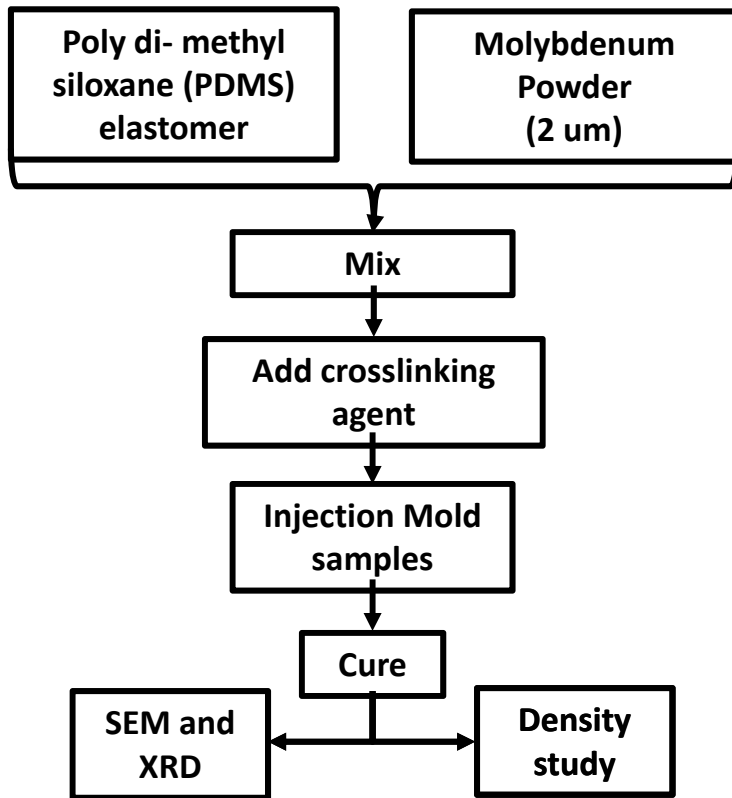

- Molar ratios of Si in PDMS and molybdenum are varied to synthesize PDCs of different compositions
- Molybdenum to silicon molar ratios 1:1, 2:1, 3:1 and 4:1 are synthesized and characterized
- PDCs are fired at a constant temperature of 1500°C in Argon atmosphere



PDMS/Mo PDC Thermolysis

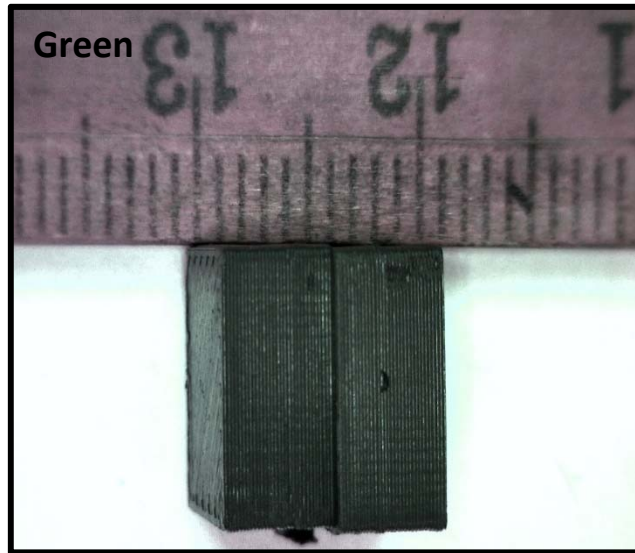

Pre-ceramic precursor: cast out of the mold

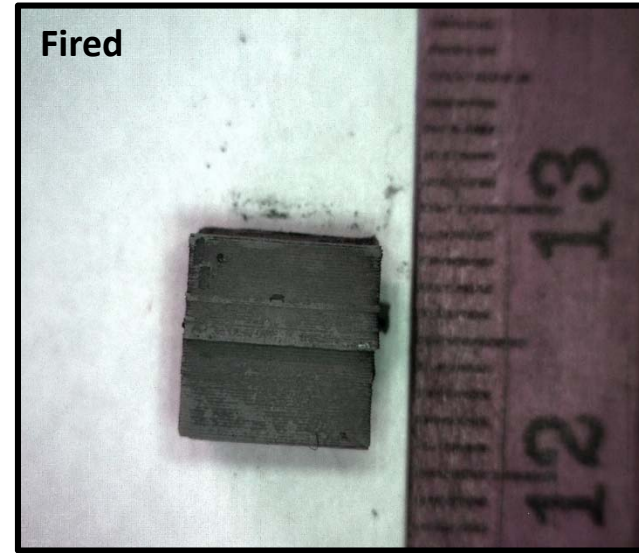

Ceramic: after fired

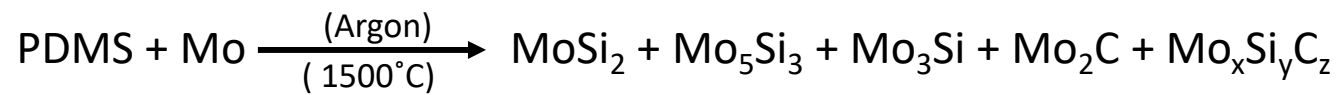

PDMS/Mo PDC: Linear and volumetric shrinkage

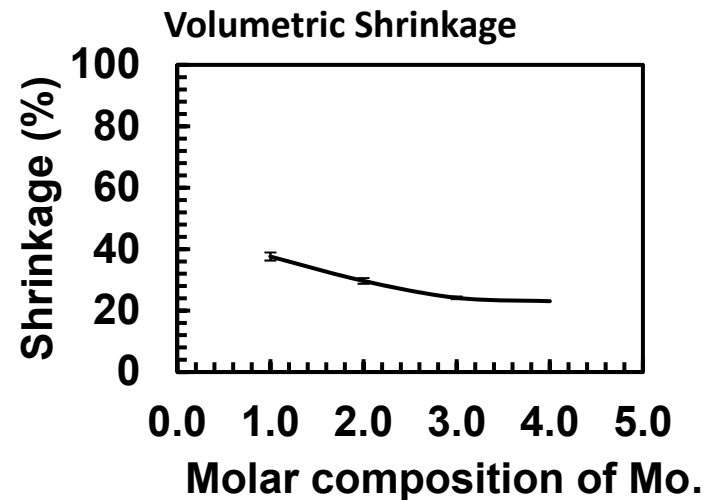
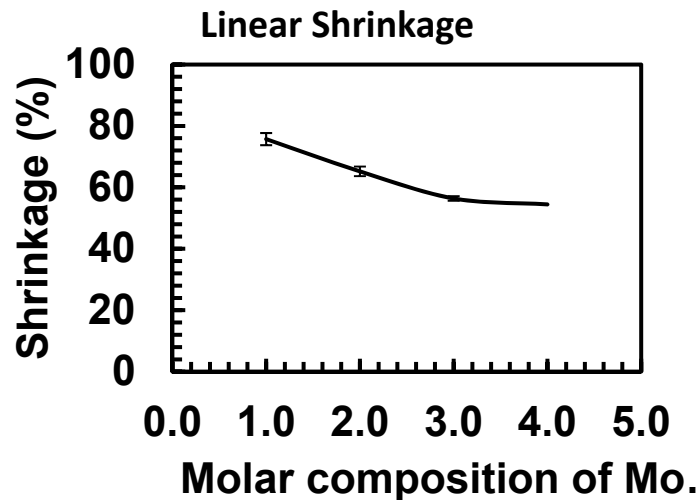

As molar ratio of molybdenum is increased, both linear and volumetric shrinkage reduces due to:

- Decreasing organic matter in the sample
- Increasing molybdenum that forms composites with silicon in the polymer



PDMS/Mo PDC: Weight loss and Densification

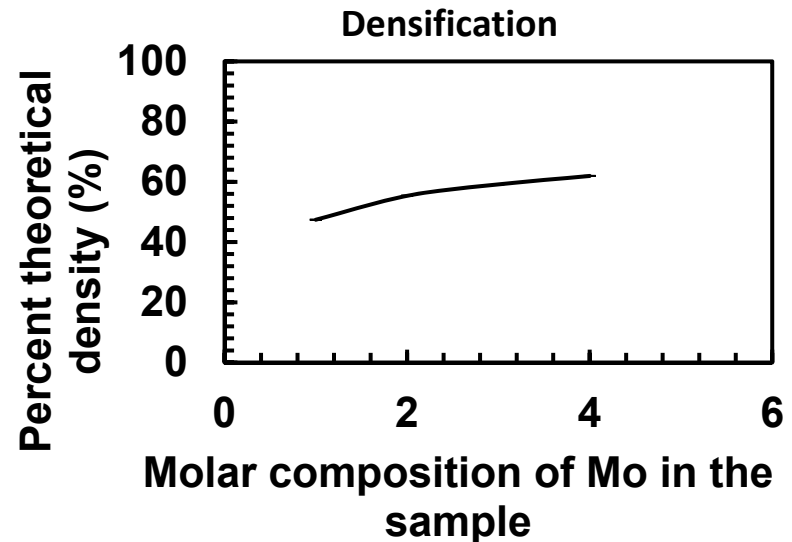
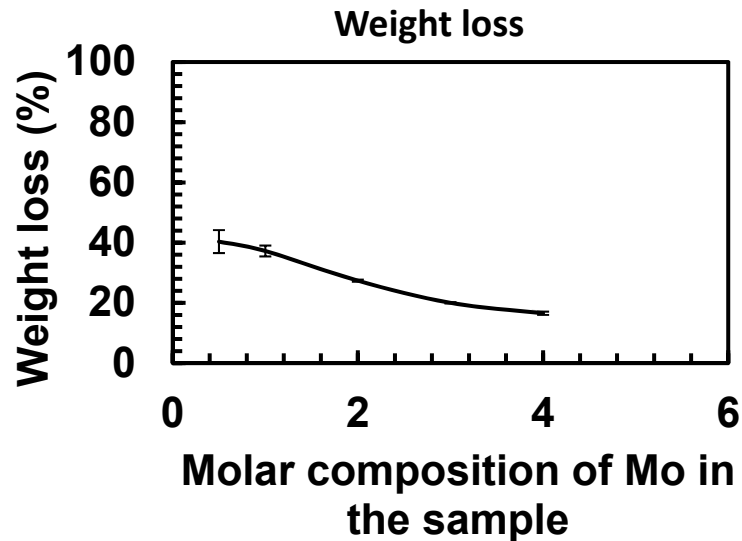

As molar ratio of molybdenum is increased,

- Weight loss decreases since there is less organic matter that decomposes and more composites are formed
- Density increases because, of less organic decomposition, there is less voids and more densification



XRD analysis of PDMS/Mo PDCs

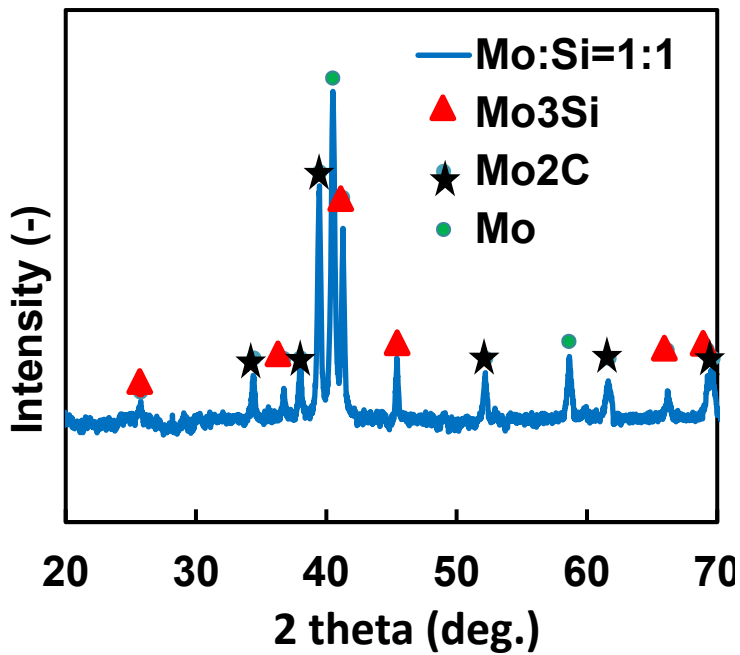

- Major phase Mo and minor phases are Mo₂C and Mo₃Si

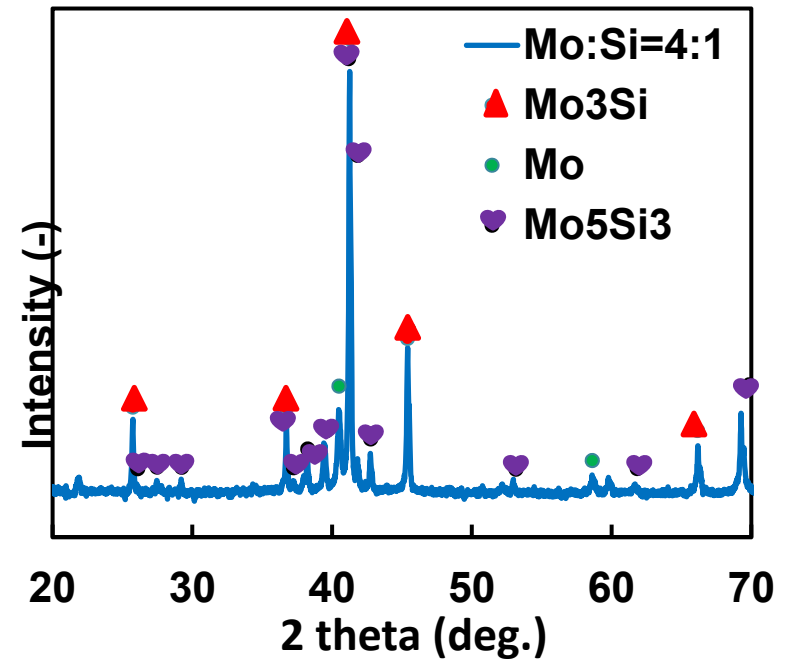

- Major phase Mo₃Si and minor phases are Mo₅Si₃ and Mo

*** Silicides are metallic in nature; carbides are semiconducting in nature.**



SEM Micrographs of PDMS/Mo-based PDCs

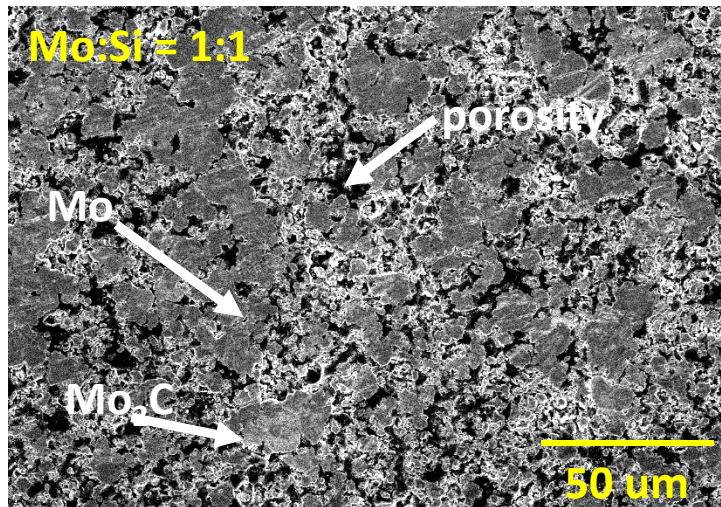

- Grain sizes are smaller
- Grains are interconnected on 3D matrix
- More gray regions- Mo,
Lighter gray regions- Mo₂C

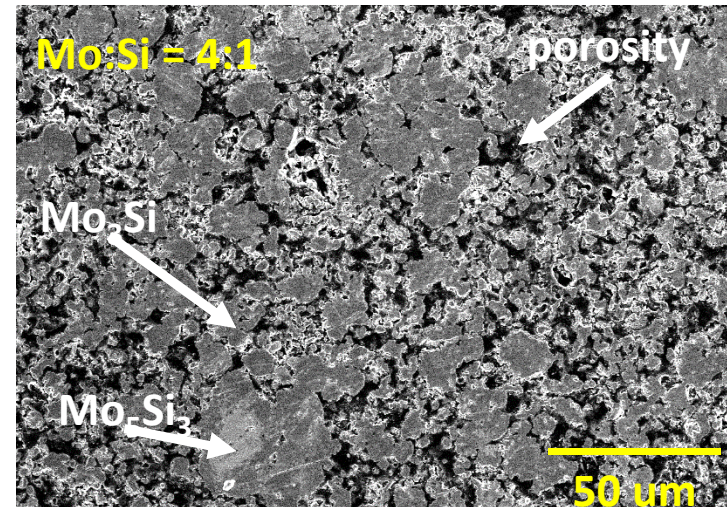

- Grain sizes are larger
- Less voids, interconnected on 3D matrix
- More gray regions- Mo₃Si,
Lighter gray regions- Mo₅Si₃



System 2: Conductive oxide- Lanthanum Nickelate

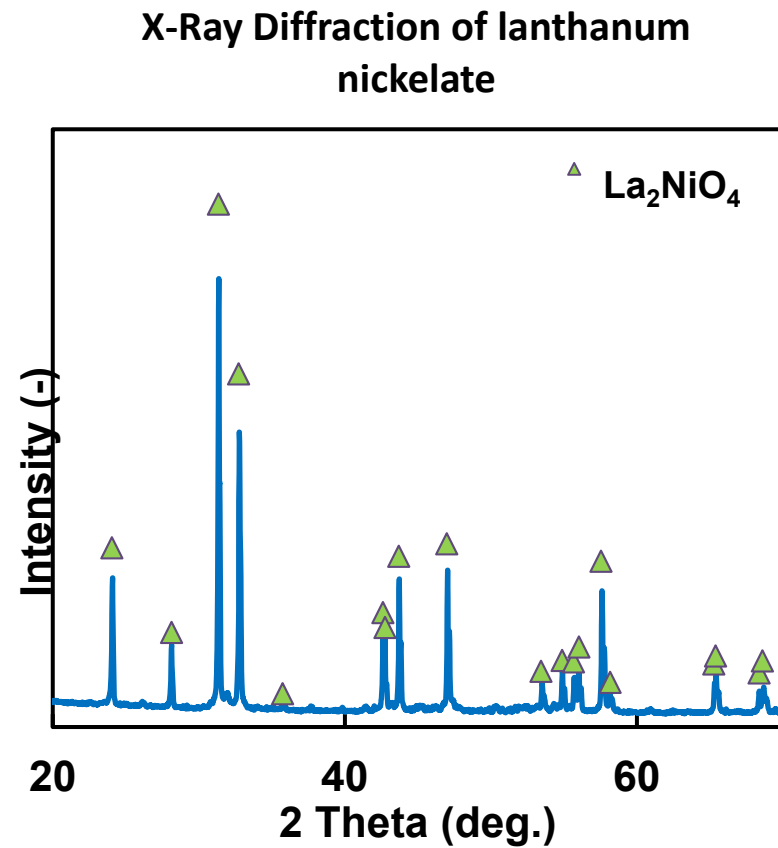
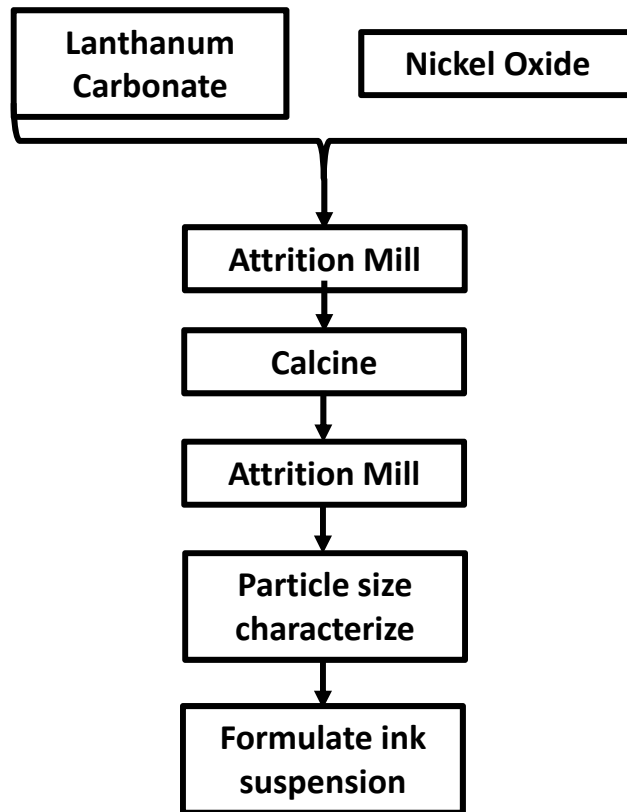

Task 2.0 Summary:

- Synthesized different silicide-carbide electroceramics using PDMS and molybdenum
 - Characterized Phase formation
 - Characterized Thermal processing
 - Quantified shrinkage and Densification
- Synthesized lanthanum nickelate and characterized

Task 2.0 Near-term Future Work:

- Synthesize:
 - Silicide-carbide systems with active (W, Ta) and inactive (Al_2O_3 , ZrO_2) fillers
 - Silicide-carbide systems using different silicon containing polymer precursors
- Effects of thermal processing
- Study Phase formation



***Task 3.0:
Direct-Writing, Patterning, and
Transfer of the Sensor System.
(Sierros/Sabolsky/Ranganathan)***



Task 3.0 Objectives:

- To define processes to direct-write through ink-jet and robo-casting the polymer-derived electroceramic composites onto oxide and polymer surfaces.
- To develop a method to transfer the pattern from an organic film to a ceramic surface and bond after thermal treatment.



Task 3.0 Approach:

- **Subtask 3.1 Direct-Writing Ink Development.**- Develop inks within a permissible surface tension and viscosity level. Direct-writing with Nordson EFD Performus VI robo-printer.
- **Subtask 3.2 Direct-Writing/Patterning and Drying Characterization.**-General process for droplet deposition, drying, and thermolysis will be defined, which includes methods to alter the wetting and drying characteristics of the deposited composite solutions.
- **Subtask 3.3 Thermal Processing Development and Structure Tailoring.**- Ink deposited directly on oxide surfaces will undergo thermal treatment defined by thermal schedules in Task 2 as a starting point.
- **Subtask 3.4 Baseline Sensor Testing and Design Optimization.**- Three initial sensor configurations (without passive communication circuit) will be designed, with focus on temperature and strain measurements. The electrical performance testing will be completed at high-temperature (500-1700°C).
- **Subtask 3.5 “Peel-and-Stick” Development.**- Investigate methods to transfer the sensor circuit/system to the active energy system component, which will be represented by alumina and zirconia substrates.



Task 3.0 Current Status:

▪Subtask 3.1 Direct-Writing Ink Development.-

- ✓ Developed inks within a permissible surface tension and viscosity level.
- ✓ Direct-writing with Nordson EFD Performus VI robo-printer.

▪Subtask 3.2 Direct-Writing/Patterning and Drying Characterization.-

- ✓ General process for droplet deposition, drying, and thermolysis are defined
- ✓ Including methods to alter the wetting and drying characteristics of the deposited composite solutions

▪Subtask 3.3 Thermal Processing Development and Structure Tailoring.-

- ✓ Ink deposited directly on oxide surfaces undergo thermal treatment defined by thermal schedules in Task 2 as a starting point.



Initial Robo-Casting Evaluation:

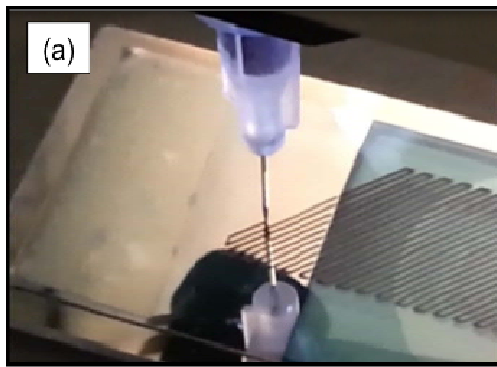

(a) Direct writing Ag ink for flexible electrodes

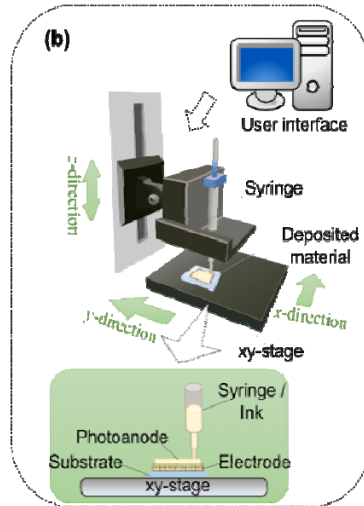

(b) Nozzle-based robotic deposition (NBRD) system and ink printing.

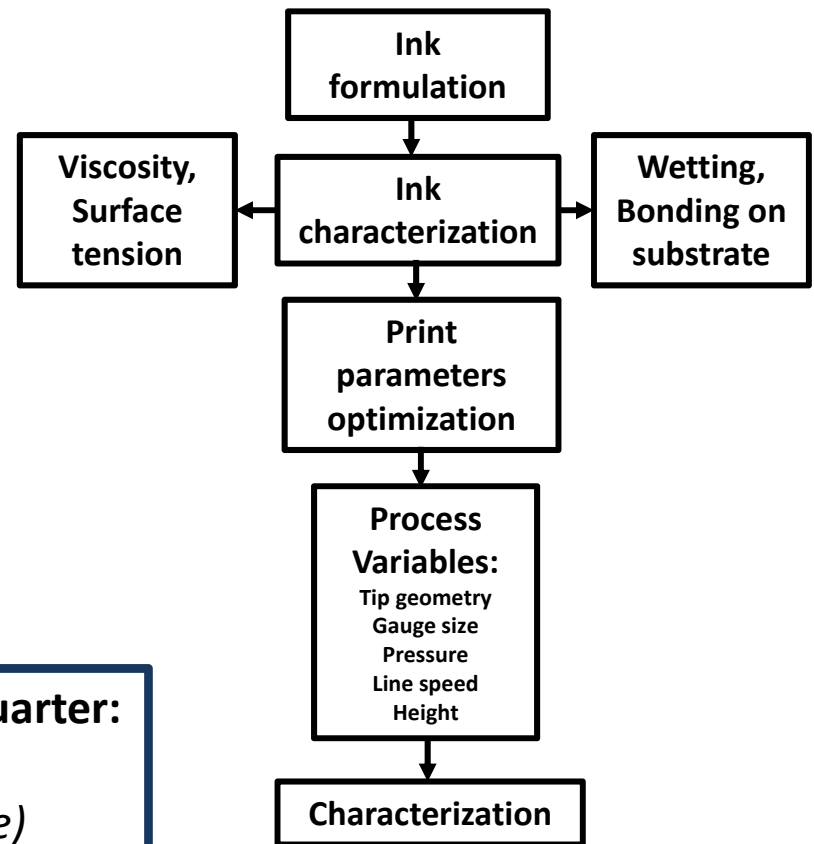

Two Systems Initially Evaluated Last Quarter:
 1) PDMS/Mo Ink (PDMS is the vehicle)
 2) LNO Suspension Ink (Terpineol vehicle)



System 1: PDMS/Mo Ink Rheology



Brookfield DV-II+ Pro
(plate-on-plate)

Key Rheology Parameters:

- 1) Shear thinning in order to extrude ink and lock the pattern
- 2) Viscosity between 300 P – 200 P is desired at shear rates $\sim 0.3 \text{ s}^{-1}$
- 3) Optimal wetting to retain dimensions

4:1 polymer pre-ceramic precursor rheology

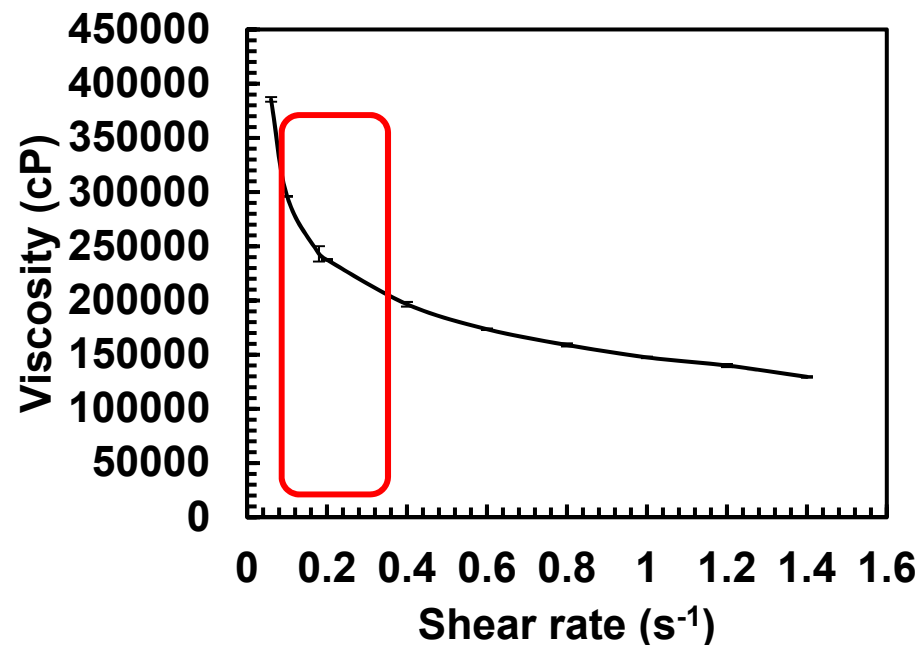

Initial Printing Evaluation of PDMS/Mo Precursor

Unfired PDC



Fired PDC



- 4:1 composition printed and thermolysed at 1500 °C
- Thickness of the line is 1 mm
- Tip type- stainless steel, Gauge size- 22, Pressure of extrusion- 30 psi, Line speed- 10mm/s and Height- ½ diameter of the tip



System 2: Conductive oxide- Lanthanum Nickelate

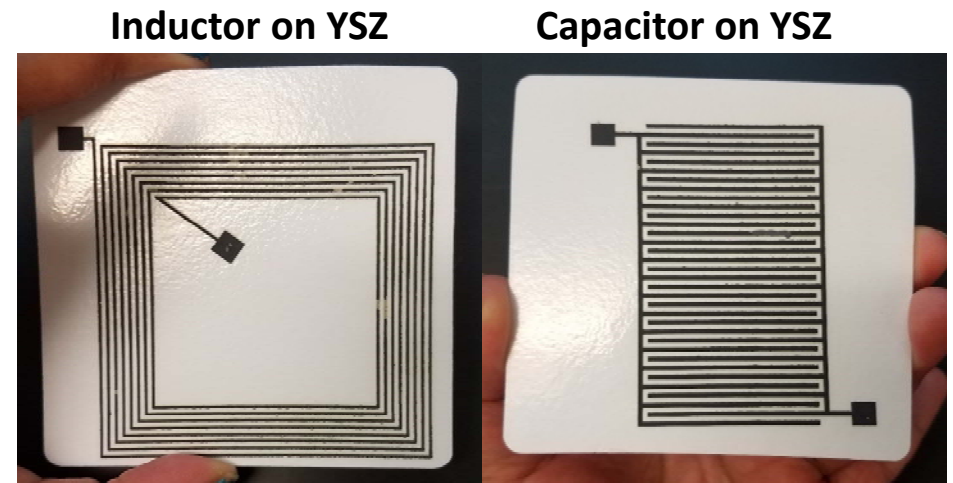
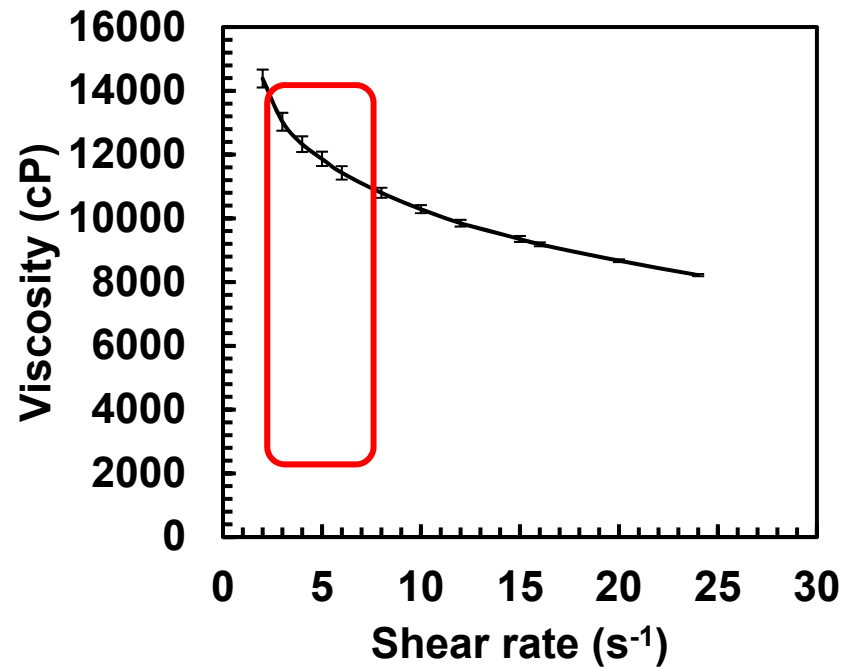

- LNO particulate suspensions are shear thinning as expected with apparent viscosity in workable range of 12 P (at shear rate of $\sim 5 \text{ s}^{-1}$)
- Screen printing of inductor and capacitor using lanthanum nickelate ink on yttria stabilized zirconia substrate



Task 3.0 Summary:

- Direct-write preceramic precursor onto oxide substrates and bond
- Screen print (to initiate task 4) silver ink and conductive oxide suspension and bond to the surface

Task 3.0 Near-term Future Work:

- Robo- cast preceramic ink precursor onto oxide substrates and optimize firing temperature for optimum density
- Achieve print resolution <100 um to print next generation LCR circuits



***Task 4.0:
Passive Wireless Communication
Circuit Design and Testing.
(Reynolds/Compartto)***



Task 4.0 Objectives:

- To design and model a passive wireless LCR circuit and receiver (reader) antennas for communication.
- To fabricate and test the sensor design and circuit at room temperature and up to 1700°C.



Task 4.0 Approach:

- **Subtask 4.1: Passive Wireless Communication Circuit Design and Testing. (Q1-4)**- This task will focus on the design of electroceramic print geometries, including width/length and spacing for the planar inductance coil, that will affect circuit component behavior in predictable and measurable ways.
- **Subtask 4.2: Circuit Fabrication and Testing at Lower Temperatures. (Q3-9)**- Ink-jet and/or robo-casting will be used to create the sensor systems using both Ag inks and the electroceramic inks developed as part of this project, and they will be tested at low temperature ($<100^{\circ}\text{C}$).



Task 4.0 Current Status:

- Built 3D and 2D models and simulations of sensors in ANSYS Software
- Built a low temperature testbed
 - Generated a data set of temperature signatures for low temperature
 - Performed preliminary low temperature passive wireless temperature sensing tests
 - Verified that preliminary sensors can accurately measure their environment's temperature



ANSYS Software

- What is ANSYS Software?
 - ANSYS Maxwell is a premier low frequency electromagnetic field simulator
 - The software utilizes finite element analysis to simulate the inductance, mutual inductance, capacitance, EM fields, and many other key features of our 3D or 2D models of our sensors
- Why is this important to the project?
 - Reduces costs
 - Adds flexibility
 - Provides sensitivity analysis
 - Provides control of the environment
 - High speed calculations and solutions
 - Helps design experimental plans to test



ANSYS Designs

- Square Planar Inductor

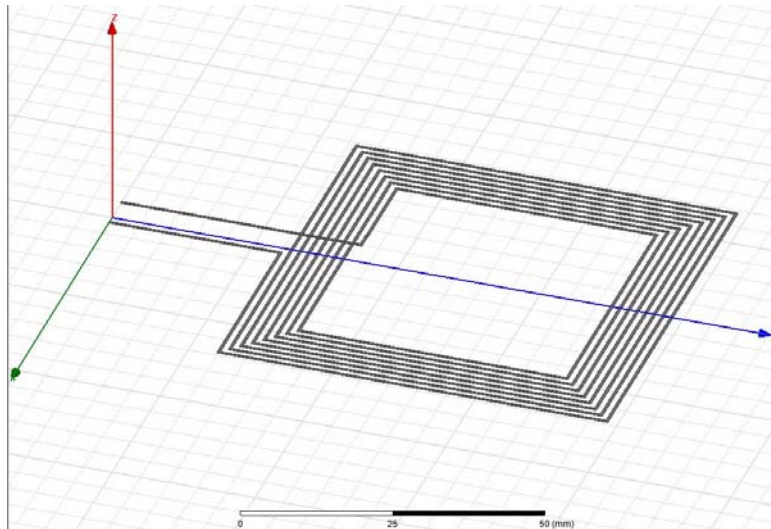

- Interdigitated Capacitor

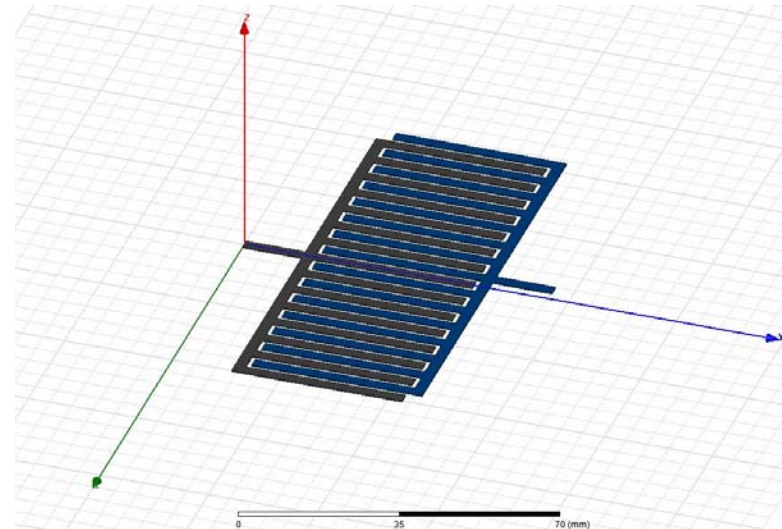

First Sensor Design in ANSYS

- Simulated Square Planar Inductor Specs
 - 8 coils
 - 68 mm wide (square)
 - $L = 6.89 \mu H$
- Simulated Interdigitated Capacitor Specs
 - 15 fingers
 - 104 mm long, 70 mm wide
 - $C = 19.82 \rho F$
- The inductance and capacitance of the printed sensor components closely matched their simulated counterparts
 - Printed sensor
 - $L = 5.82 \mu H$
 - $C = 19.9 \rho F$
- The resonant frequency of the sensor closely matched the resonant frequency of the simulated sensor
 - $f_{res} = 12 MHz$ (printed sensor)
 - $f_{res} = 13.61 MHz$ (simulated sensor)



ANSYS EM simulation

- Simulation of the EM field around the square planar inductor

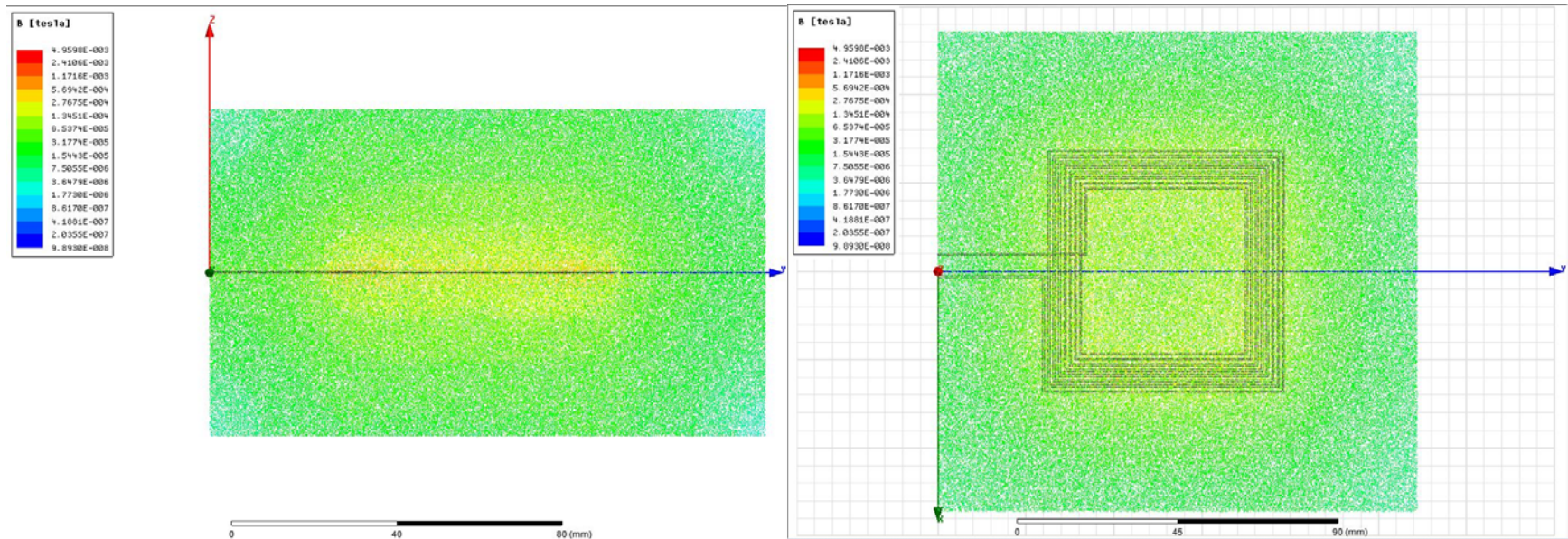

ANSYS Sensor Development

- Because we have laid the ground work in building the 3D simulations of our sensor
 - We can now quickly change the models of our sensors and tailor them to what we need

2 in by 2 in Sensor Design

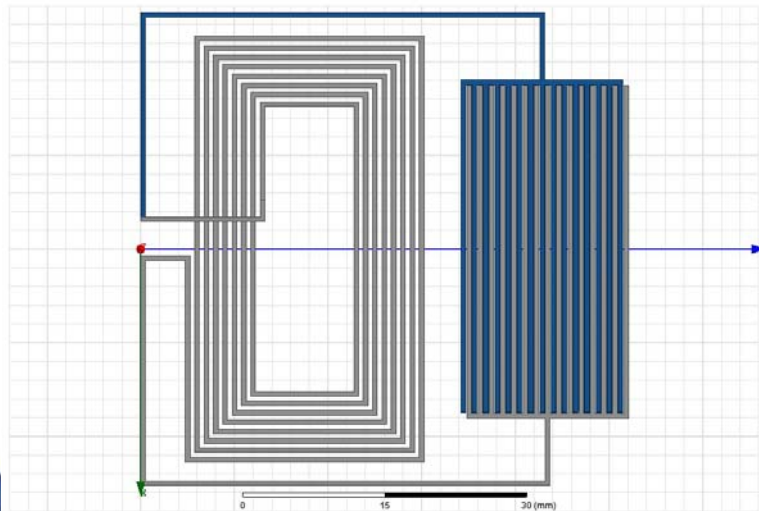

1 in by 1 in Sensor Design

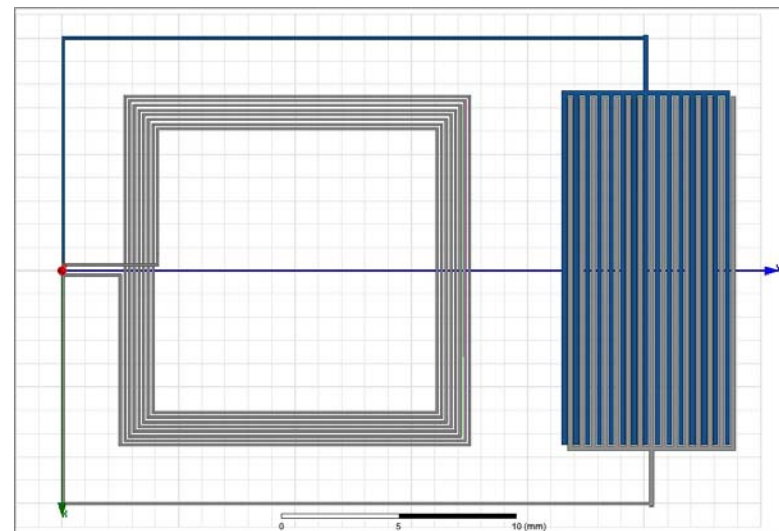

Challenges Faced in Wireless Communications

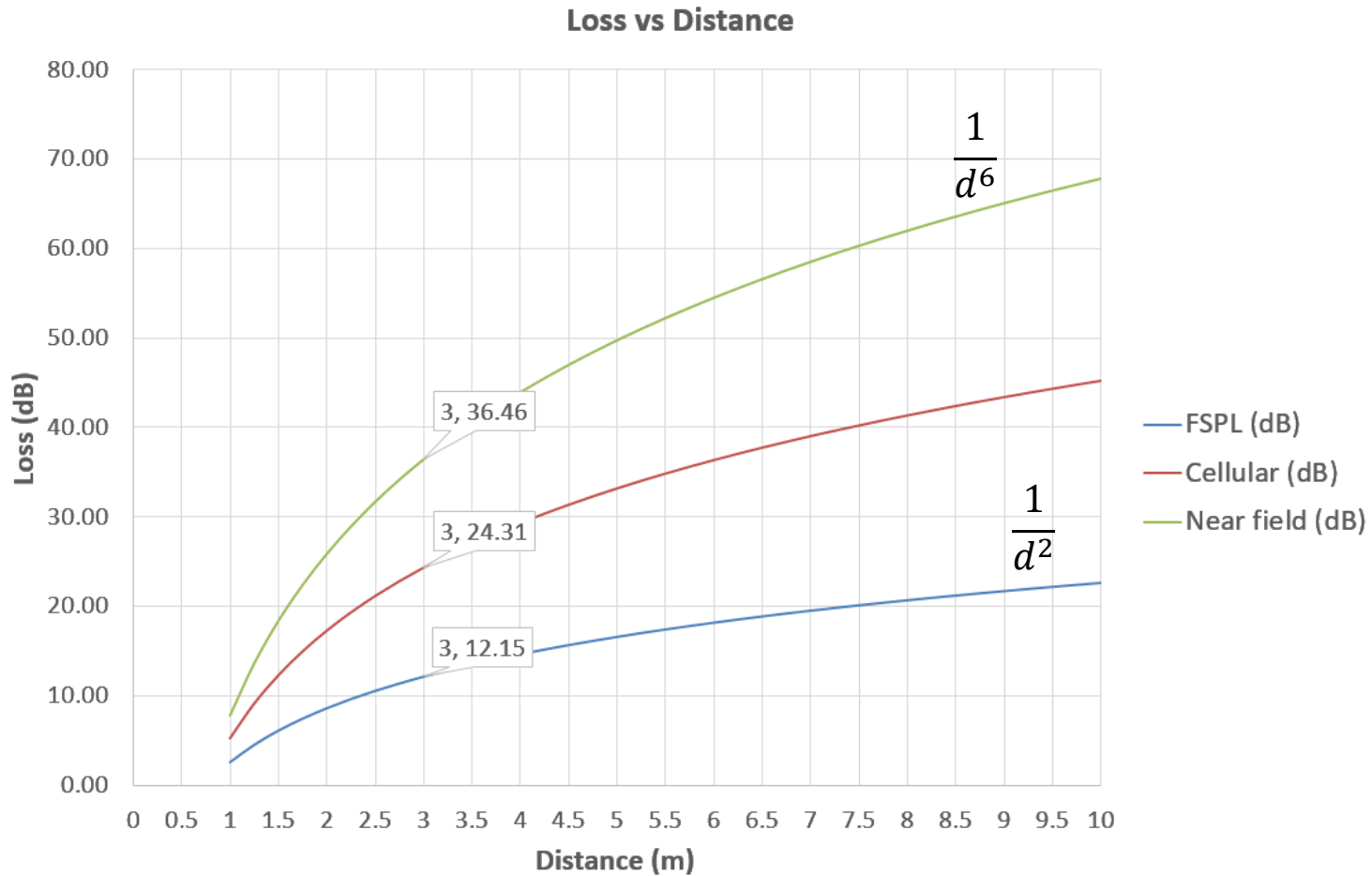

Passive Wireless Temperature Sensor

- Preliminary passive wireless low temperature sensor
 - Silver Ink on reflective paper
 - Next phase of temperature testing will use ceramic based sensors.

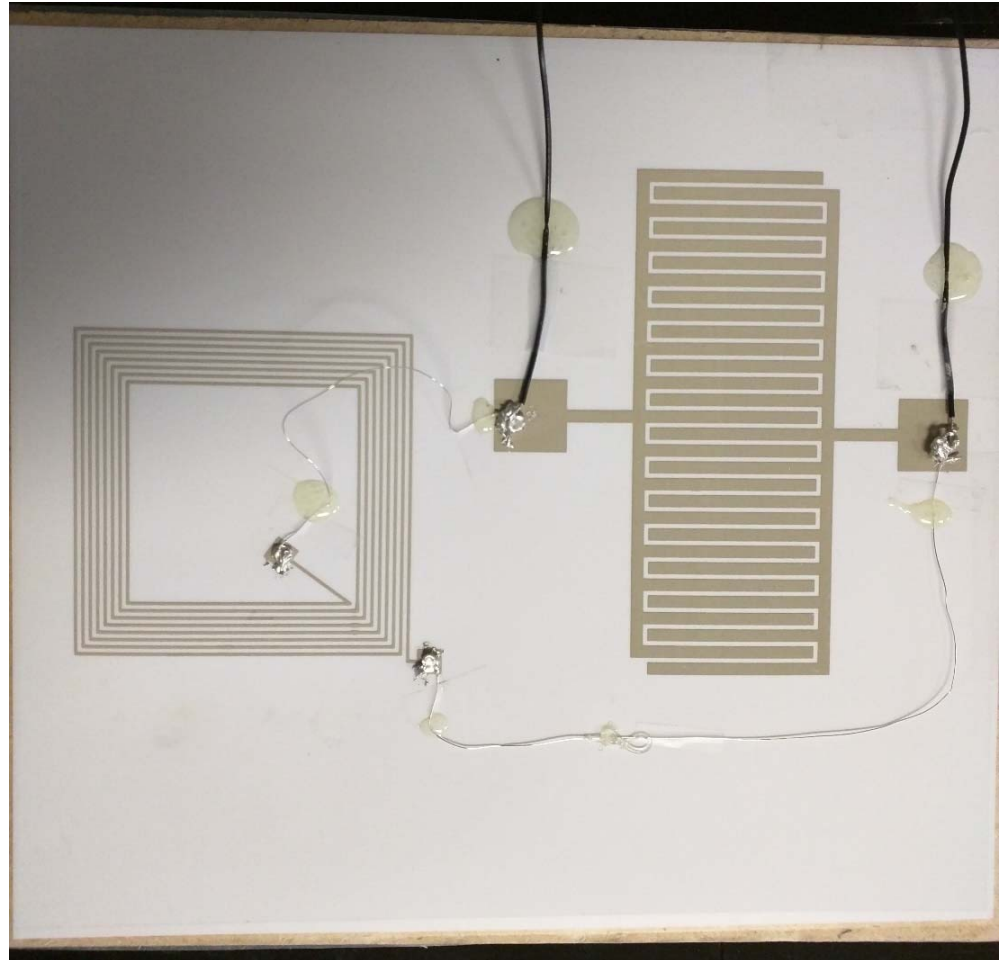

Passive Wireless Temperature Sensing Testbed

Spectrum Analyzer

Transmit and Receive Sensors

Signal Generator

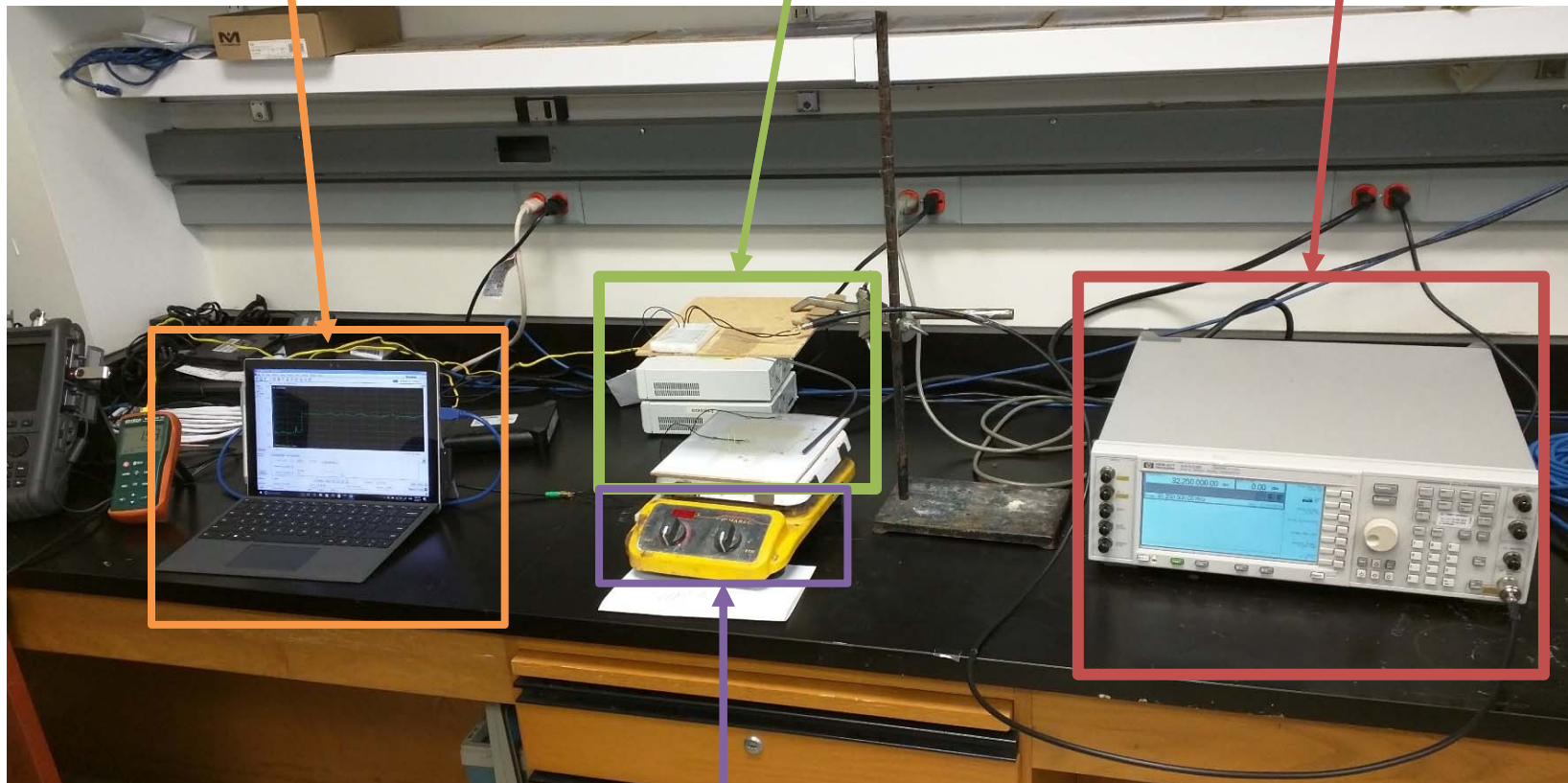

Hot Plate



Sensor Characterization (Distance Test)

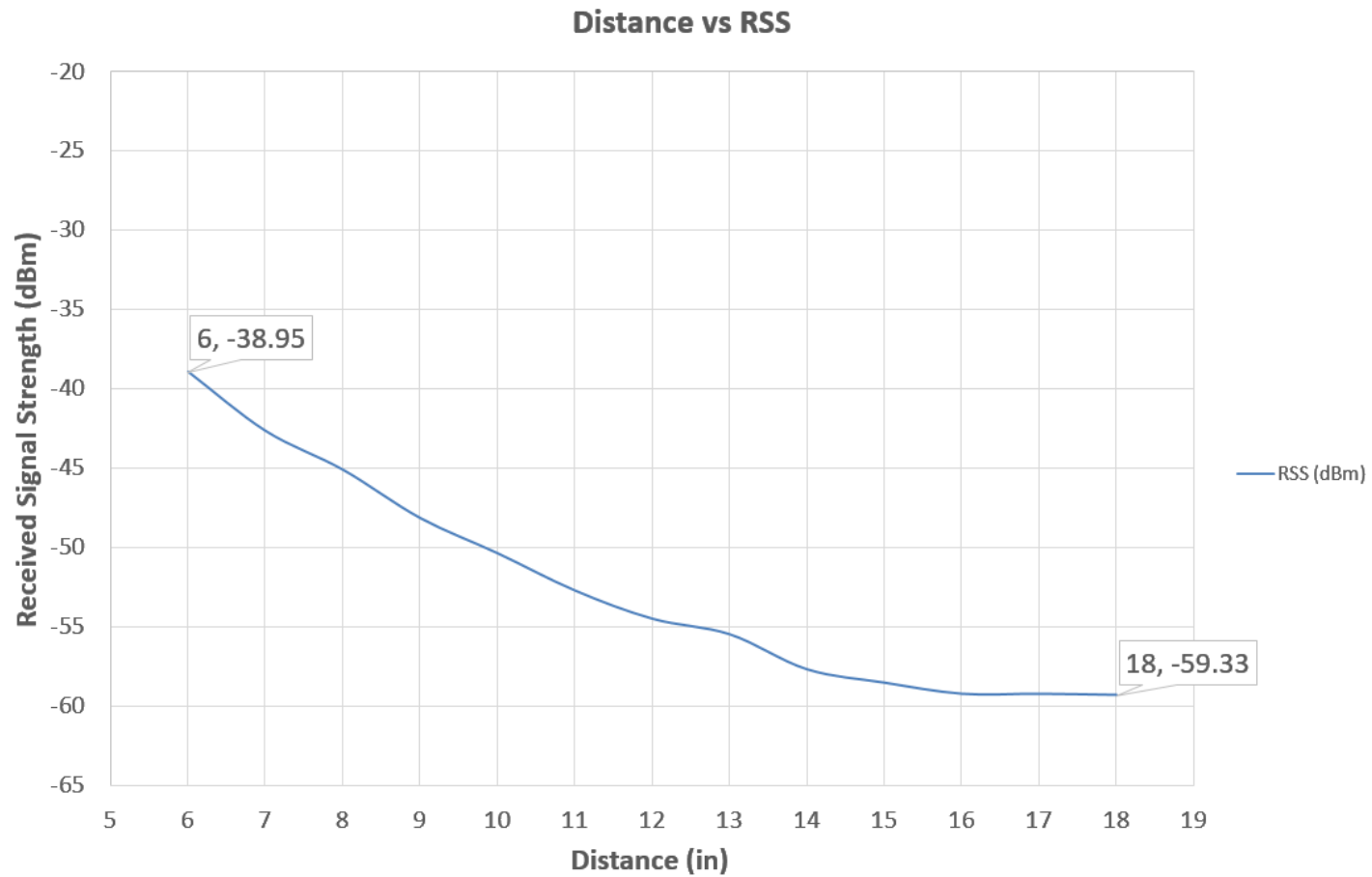

Sensor Characterization (Frequency Response)

Sensor Frequency Response (0 - 200 MHz)

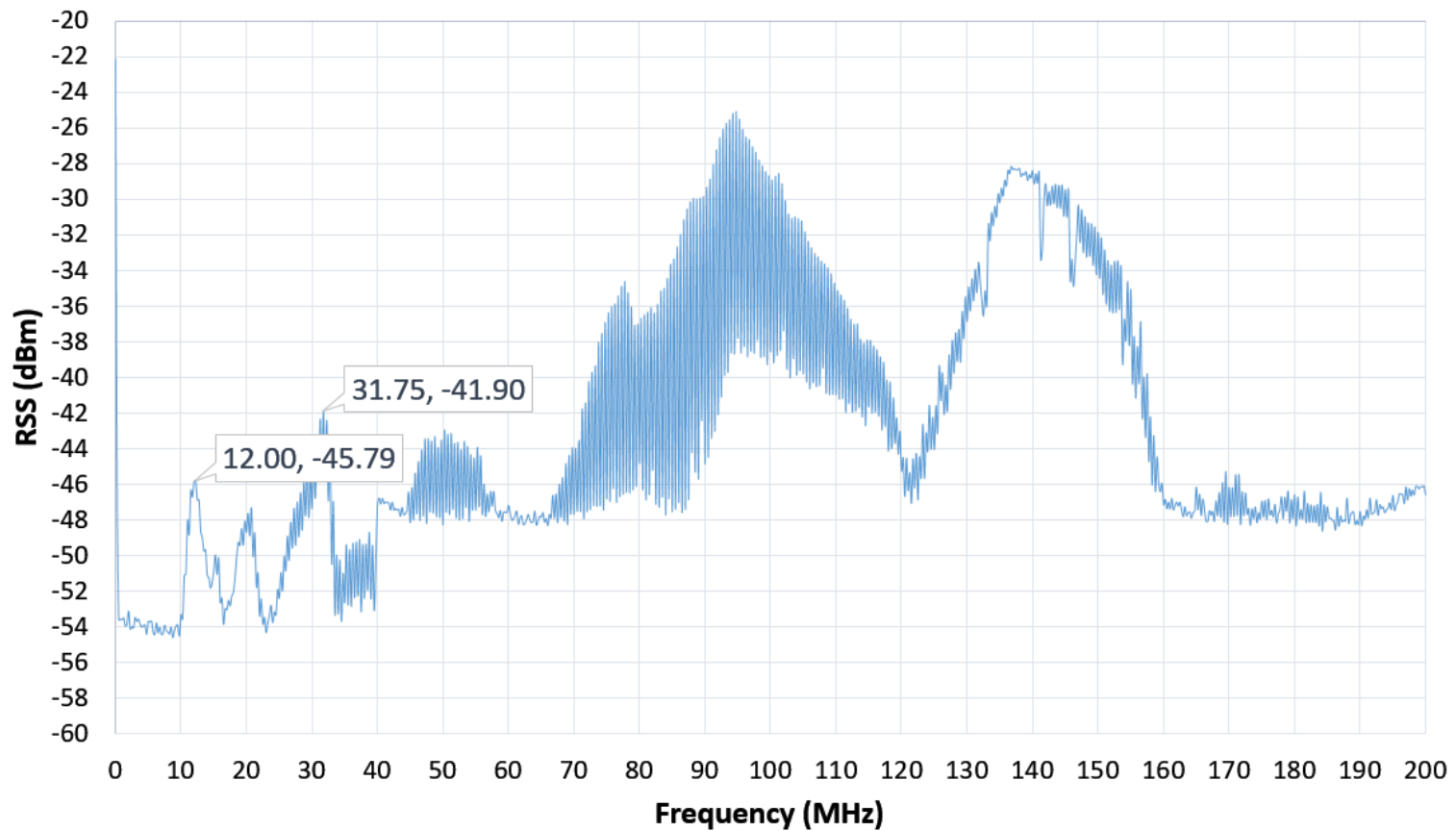

Passive Wireless Temperature Reading

- We use a large band of spectrum (many degrees of freedom) to measure temperature
 - This is a more robust method
 - Allows for the application of advanced signal processing methods from fields like wireless communications, Radar, digital image processing, Radio Astronomy
- In the past, other works have used peak tracking (few degrees of freedom)
 - Heavily reliant on the peak's sensitivity to changes in temperature
- Method 1: Correlation
 - $\hat{T} = \operatorname{argmax}_T \int_{-\infty}^{\infty} y(t) * s_T(t) dt$
 - where $s_{T(t)}$ is the signature waveform for temperature T , $y(t)$ is the unknown temperature frequency sweep, and \hat{T} is the estimated temperature
 - Choose the temperature signature the maximizes the correlation
 - This is the closest match to the unknown temperature



Passive Wireless Temperature Reading

Spectrum sweep taken at a random temperature. In this example the unknown temperature is 50 C

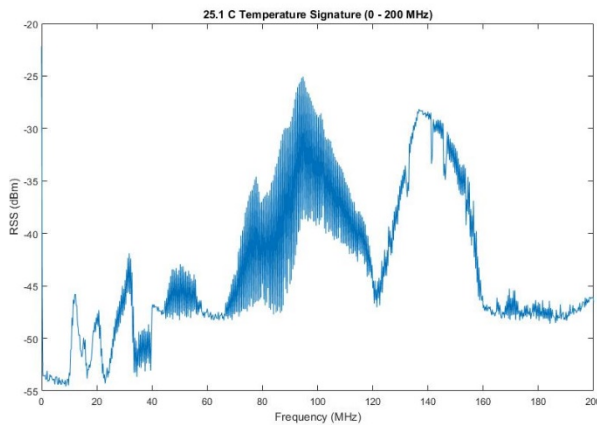
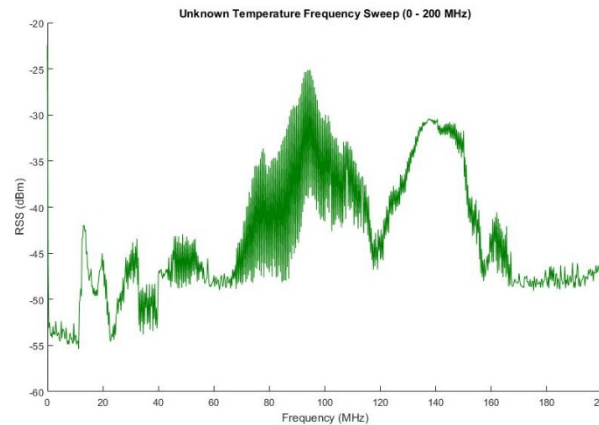

Signature for 25.1 C

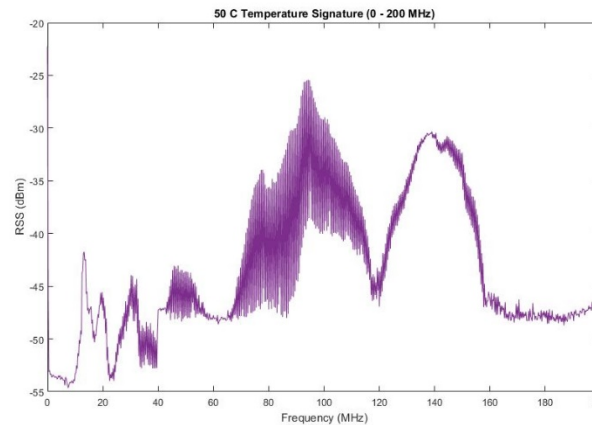

Signature for 50 C

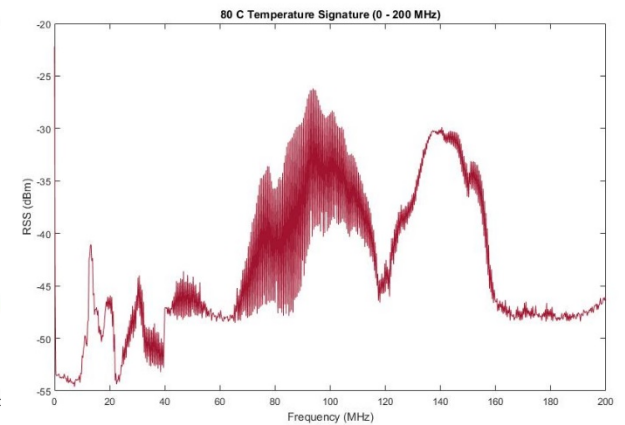

Signature for 80 C



Passive Wireless Temperature Reading

Spectrum sweep taken at a random temperature. In this example the unknown temperature is 50 C

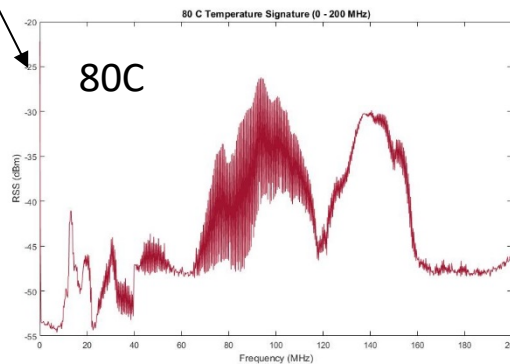
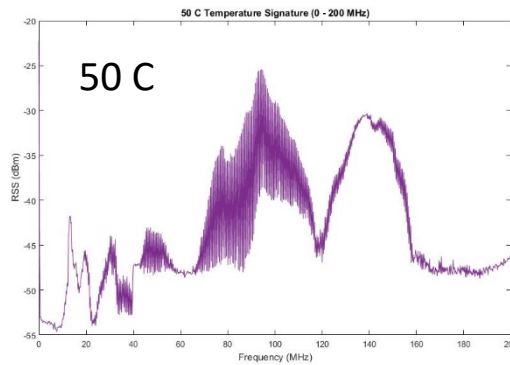
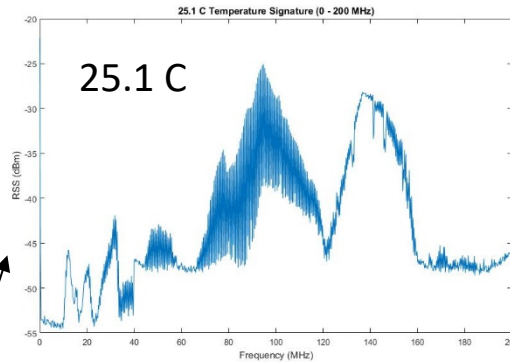
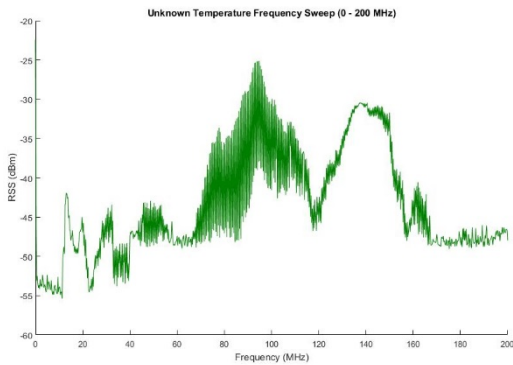

Method	Correlation	Abs. Error
25.1 C	0.9990	1078
50 C	0.9997	542.1
80 C	0.9994	803.3



Absolute Difference between Unknown Temperature and Temperature Signatures

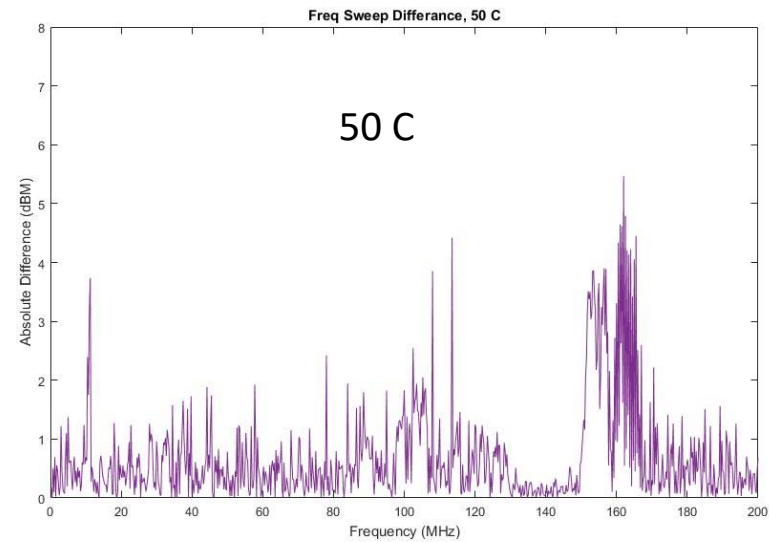
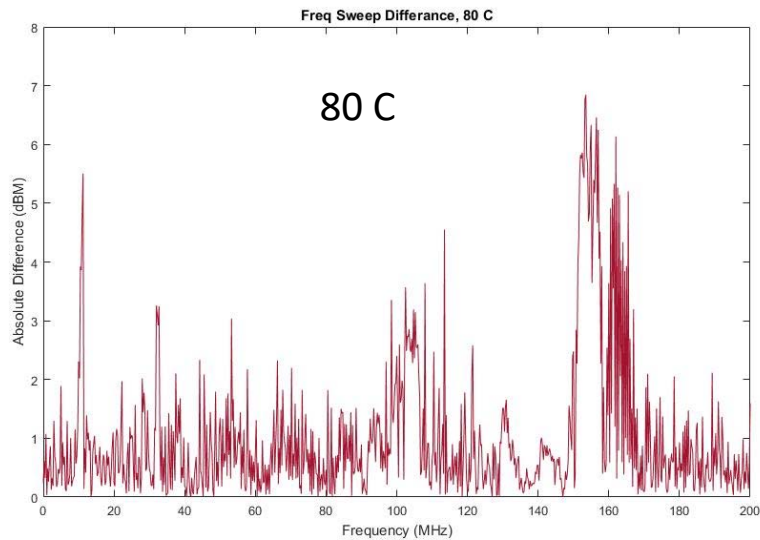
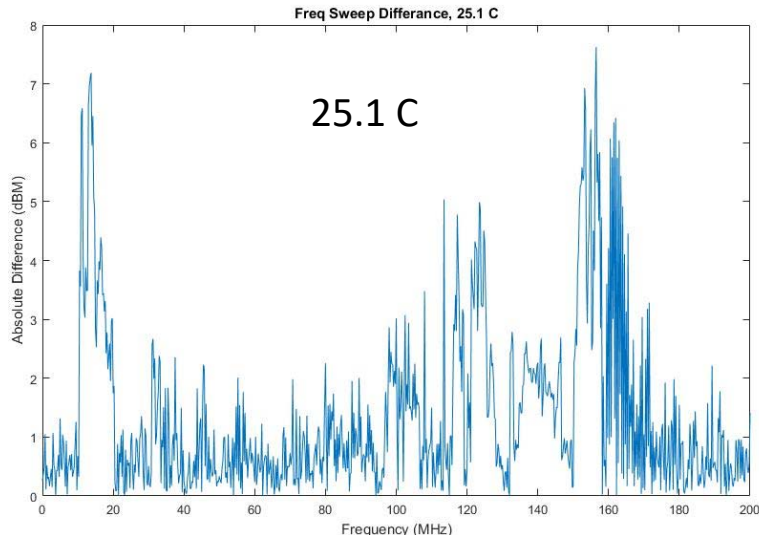

Shift in Frequency Response due to Temperature Increase

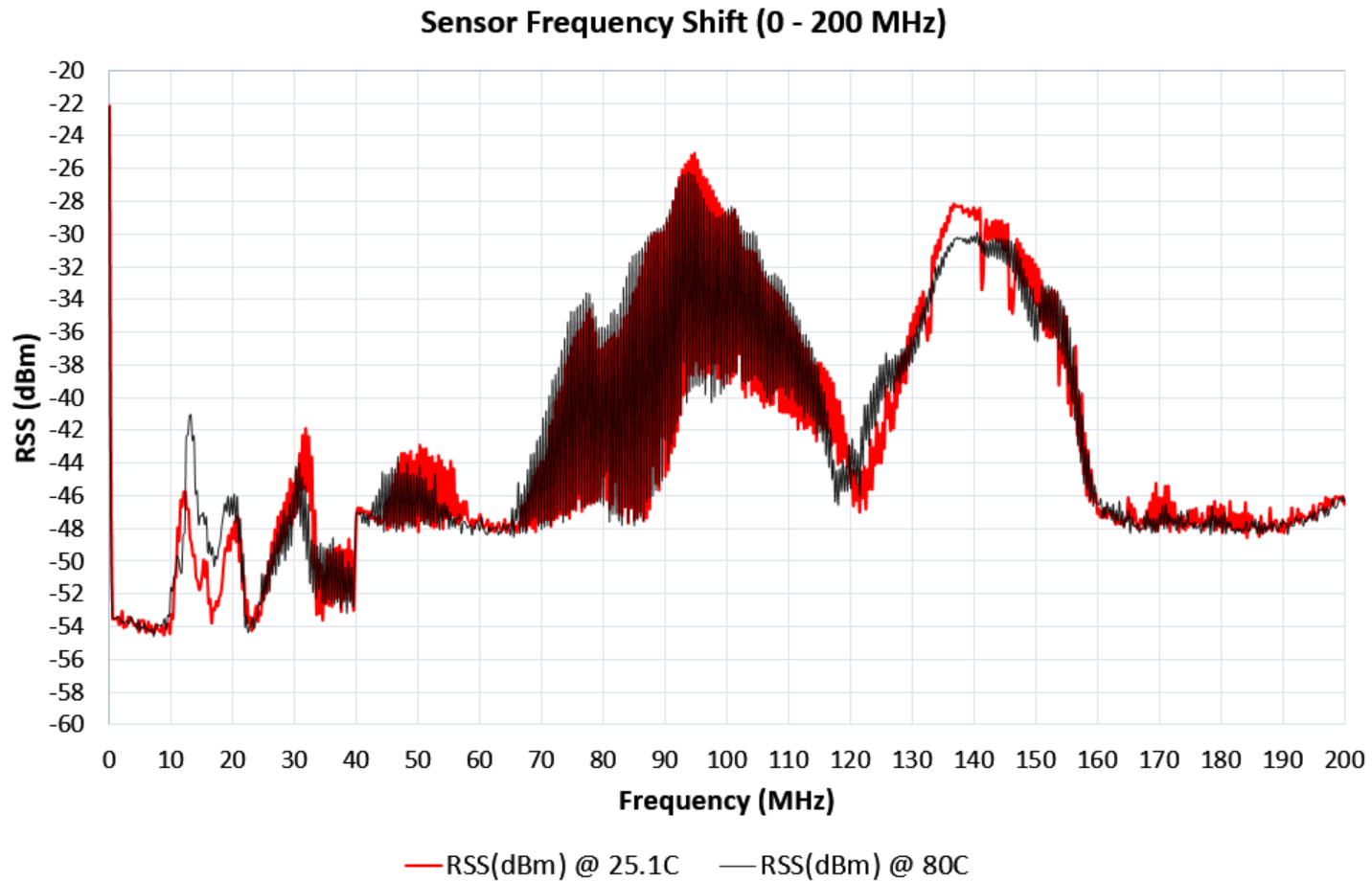

Task 4.0 Summary:

- Completed preliminary low temperature passive wireless temperature sensing
 - Built 3D models and simulations of sensor designs
 - Created a low temperature sensing testbed
 - Demonstrated ability to accurately sense the temperature of the sensor's environment
 - Verified the accuracy of the 3D models and simulations

Task 4.0 Near-term Future Work:

- Continue to build 3D models of sensor to fit inside of 2in and 1in squares
- Build a high temperature testbed
 - Generate a high temperature database
 - Start running high temperature sensing tests



Acknowledgments:

- ❖ We would like to thank **U.S. Department of Energy (DOE)** for sanctioning this project **DE-FE0026171**.
- ❖ Jessica Mullen, project manager at U. S. Department of Energy, is greatly appreciated for her insight and valuable guidance.
- ❖ We also would like to acknowledge Dr. Wei Ding, Dr. Marcela Redigolo and Mr. Harley Hart for their cooperation and valuable assistance in the WVU Shared Facilities.
- ❖ Kindly acknowledge Faculty and staff of West Virginia University for their support.

